

## Data Sheet

**Customer:**

**Product:** Automotive Grade Wire Wound Common Mode Filter–CFH..A series

**Sizes.:** 1210/1812

**Issued Date:** 09-May-19

**Edition:** REV.A1



VIKING TECH CORPORATION  
光韻科技股份有限公司  
No.70, Guangfu N. Rd.,  
Hukou Township, Hsinchu County  
303, Taiwan (R.O.C)

TEL:886-3-5972931  
FAX:886-3-5972935•886-3-5973494  
E-mail:sales@viking.com.tw

VIKING TECH CORPORATION KAOHSIUNG BRANCH  
光韻科技股份有限公司高雄分公司  
No.248-3, Sin-Sheng Rd., Cian-Jhen Dist., Kaohsiung,  
806, Taiwan

TEL:886-7-8217999  
FAX:886-7-8228229  
E-mail:sales@viking.com.tw

VIKING ELECTRONICS (WUXI) CO., LTD.  
光韻電子(無錫)有限公司  
No.22 Xixia Road, Machinery & Industry Park,  
National Hi-Tech Industrial Development Zone  
of Wuxi, Wuxi, Jiangsu Province, China  
Zip Code:214028  
TEL:86-510-85203339  
FAX:86-510-85203667•86-510-85203977  
E-mail:china@viking.com.tw

Produced by (QC)	Checked (QC)	Approved by (QC)	Prepared by (Sales)	Accepted by (Customer)
09-May-19	09-May-19	09-May-19	09-May-19	
<i>Kris Chen</i>	<i>Ben Chang</i>	<i>Ben Chang</i>		

## Automotive Grade Wire Wound Common Mode Filter



### ■ Features

- High common mode impedance at high frequency effects excellent noise suppression performance
- Small sizes and low profile
- 100% Lead(Pb) & Halogen-Free and RoHS compliant
- AEC-Q200 Compliance

### ■ Applications

- DSI / BST / CAN-Bus / Flex-Ray

### ■ Construction

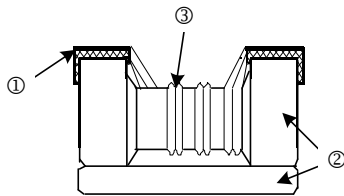

① Terminal	② Ferrite	③ Enameled Copper Wire
------------	-----------	------------------------

### ■ Dimensions

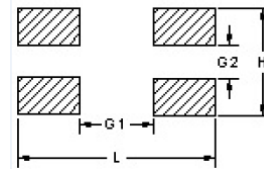
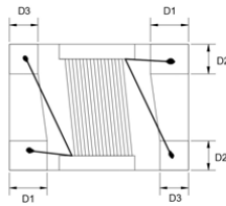
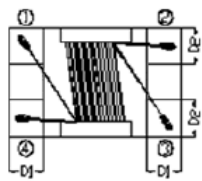
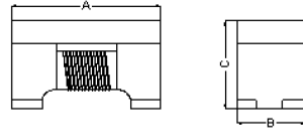
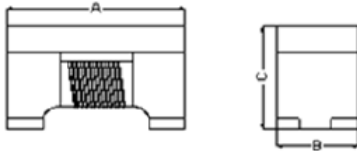

1210

1812

Unit : mm

Type	Size (Inch)	A	B	C	D1	D2	D3	L	H	G1	G2
CFH10	1210	3.3±0.2	2.5±0.2	2.5 max	0.55±0.15	0.75±0.2	—	3.7	2.8	2.4	1.2
CFH12	1812	4.5±0.2	3.2±0.2	2.8±0.2	0.75±0.2	0.85±0.2	0.60±0.2	5.0	3.6	3.4	1.7

**Automotive Grade Wire Wound Common Mode Filter**

**Part Numbering**

CF	H	10	O	T	110	A
Product Type	Shielding Type H: Shielding	Dimensions 10: 1210 12: 1812	Inductance Tolerance O: +50/-30%	Packaging Code T: Taping Reel	Inductance 110: 11uH 220: 22uH 510: 51uH 101: 100uH	Function Code A: Automotive Grade

**Standard Electrical Specifications**

CFH10 / Standard Type

Part No.	Impedance(Ω) @10MHz		Inductance(uH) @100KHz, 0.1V	Inductance Tolerance	DCR (Ω) max.	IDC (mA) max.	Rated Voltage Vdc (V) typ.	Insulation Resistance (MΩ) min.
	min.	typ.						
CFH100T110A	300	550	11	+50/-30%	0.4	300	80	10
CFH100T220A	500	1100	22	+50/-30%	0.5	250	80	10
CFH100T510A	1000	2600	51	+50/-30%	0.7	200	80	10
CFH100T101A	2200	5100	100	+50/-30%	1.5	150	80	10

CFH12 / Standard Type

Part No.	Impedance(Ω) @10MHz		Inductance(uH) @100KHz, 0.1V	Inductance Tolerance	DCR (Ω) max.	IDC (mA) max.	Rated Voltage Vdc (V) typ.	Insulation Resistance (MΩ) min.
	min.	typ.						
CFH120T110A	300	600	11	+50/-30%	0.6	360	50	10
CFH120T220A	500	1200	22	+50/-30%	1.0	310	50	10
CFH120T510A	1000	2800	51	+50/-30%	1.0	230	50	10
CFH120T101A	2000	5800	100	+50/-30%	2.0	200	50	10

**Schematic Diagram**

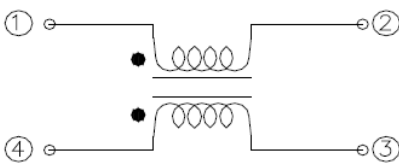

**Measuring Circuits 2Line**

Common mode

Differential mode

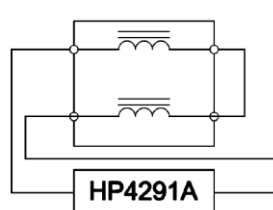
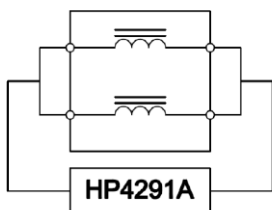

**Automotive Grade Wire Wound Common Mode Filter**

**Characteristics (Impedance vs. Frequency)-CFH10**

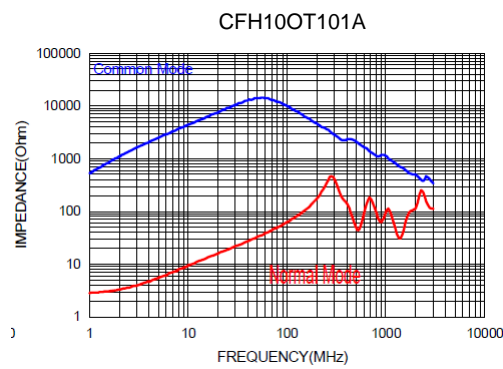
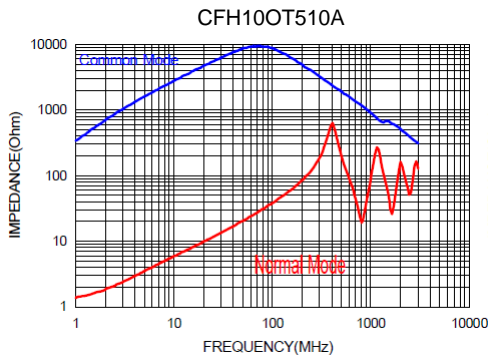
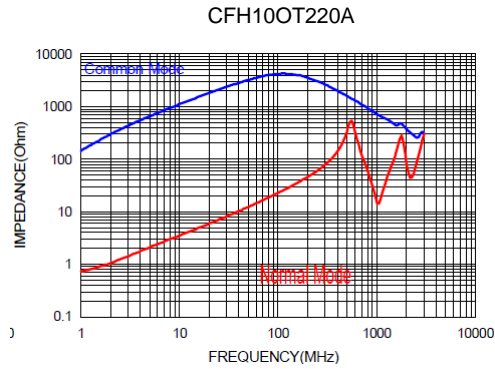
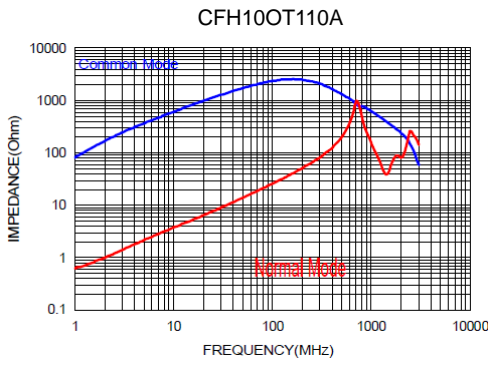

**Characteristics (Impedance vs. Frequency)-CFH12**

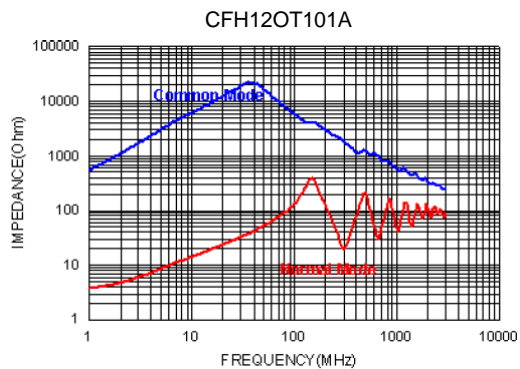
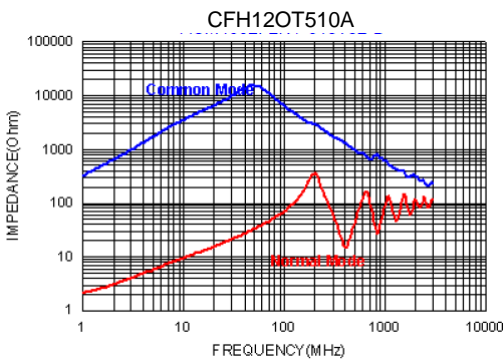
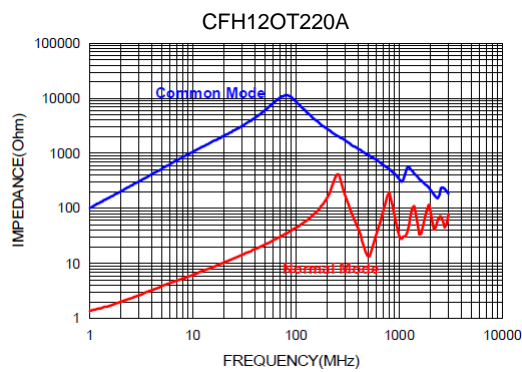
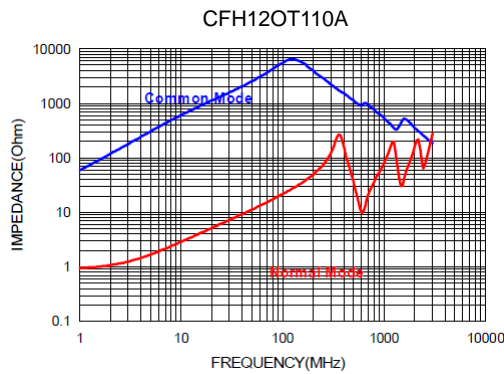

**Automotive Grade Wire Wound Common Mode Filter**

**Environmental Characteristics**

Electrical Performance Test

Items	Requirement	Test Methods
Inductance	Refer to standard electrical characteristic spec. Component should not be damaged	LCR Meter HP 4291A+16197A
DC Resistance DCR		Agilent-4338B
Insulation Resistance (I.R)		Agilent-4339
Temperature Rise Test	Rated current<1A $\Delta T20^{\circ}\text{C}$ max Rated current>1A $\Delta T40^{\circ}\text{C}$ max	Applied the allowed DC current Temperature measured by digital surface thermometer

Mechanical Performance Test

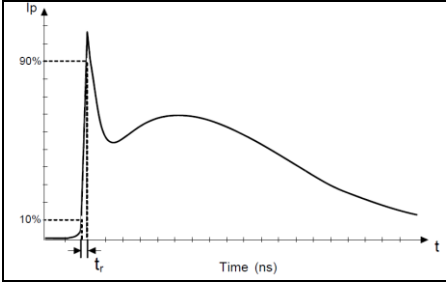
Items	Requirement	Test Methods
High Temperature Exposure	Appearance: No damage Impedance: Within $\pm 15\%$ of initial value Inductance: Within $\pm 10\%$ of initial value RDC: Within $\pm 15\%$ of initial value and Shall not exceed the specification value	at $+150^{\circ}\text{C}$ for 1000 hrs Measured at room temperature after placing for $24\pm 2$ hrs
Temperature Cycling		$-55^{\circ}\text{C}$ to $+150^{\circ}\text{C}$ , 1000 hrs Measured at room temperature after placing for $24\pm 2$ hrs
Moisture Resistance		1.Baked at $50^{\circ}\text{C}$ for 25hrs, measured at room temperature after placing for 4 hrs. 2.Raise temperature to $65\pm 2^{\circ}\text{C}$ 90-100%RH in 2.5hrs, and keep 3 hours, cool down to $25^{\circ}\text{C}$ in 2.5hrs. 3.Raise temperature to $65\pm 2^{\circ}\text{C}$ 90-100%RH in 2.5hrs, and keep 3 hours, cool down to $25^{\circ}\text{C}$ in 2.5hrs,keep at $25^{\circ}\text{C}$ for 2hrs then keep at $-10^{\circ}\text{C}$ for 3hrs 4.Keep at $25^{\circ}\text{C}$ 80-100%RH for 15min and vibrate at the frequency of 10 to55 Hz to 10 Hz, measure at room temperature after placing for 1~2 hrs.
Biased Humidity		1000 hrs $85^{\circ}\text{C}/85\%\text{RH}$ 100% rated current Measured at room temperature after placing for $24\pm 2$ hrs
Operational Life		at $+150^{\circ}\text{C}$ for 1000 hrs with 100% rated current Measured at room temperature after placing for $24\pm 2$ hrs
External Visual	Appearance : No damage	Inspect device construction, marking and workmanship. Electrical Test not required.
Physical Dimension	According to the product specification size measurement	According to the product specification size measurement
Resistance to Solvents	Appearance: No damage	Add aqueous wash chemical - OKEM clean or equivalent
Mechanical Shock	Appearance: No damage Impedance: Within $\pm 15\%$ of initial value Inductance: Within $\pm 10\%$ of initial value RDC: Within $\pm 15\%$ of initial value and Shall not exceed the specification value	Wave form: sine shock Peak value is 100g's. Normal duration (D) is 6ms shocks in each direction along 3 perpendicular axes. Oscillation Frequency: 10~2K~10Hz for 20 minute Equipment : Vibration checker Total Amplitude:1.52mm $\pm 10\%$ Testing Time : 12 hours(20 minutes, 12 cycles each of 3 orientations)
Vibration		
Resistance to Soldering Heat		$260\pm 5^{\circ}\text{C}$ for $10\pm 1$ seconds
Thermal shock		$-55^{\circ}\text{C}$ to $+150^{\circ}\text{C}$ , 300 cycles Measured at room temperature after placing for $24\pm 2$ hrs
ESD	Appearance: No damage	

**Automotive Grade Wire Wound Common Mode Filter**

Items	Requirement	Test Methods
Solderability	95% min. coverage	Steam Aging: 8 hours ± 15 min, Preheat: 150°C, 60sec. Solder: Sn96.5% Ag3% Cu0. 5%, Temperature: 245±5°C ° Flux for lead free: Rosin. 9.5%, Dip time: 4±1sec. Depth: completely cover the termination
Electrical Characterization	Refer Specification for Approval	Summary to show Min, Max, Mean and Standard deviation
Flammability	Electrical Test not required	V-0 or V-1 are acceptable
Board Flex	Appearance : No damage	Place the 100mm X 40mm board into a fixture similar to the one shown in below Figure with the component facing down. The apparatus shall consist of mechanical means to apply a force which will bend the board (D) x = 2 mm minimum. The duration of the applied forces shall be 60 (+ 5) sec. The force is to be applied only once to the board  
Terminal Strength(SMD)	Appearance : No damage	With the component mounted on a PCB with the device to be tested, apply a 17.7 N (1.8 Kg) force to the side of a device being tested. This force shall be applied for 60 +1 seconds. Also the force shall be applied gradually as not to apply a shock to the component being tested  

■ **Storage Temperature: 15~28°C; Humidity < 80%RH**

The condition of reflow (recommendation):

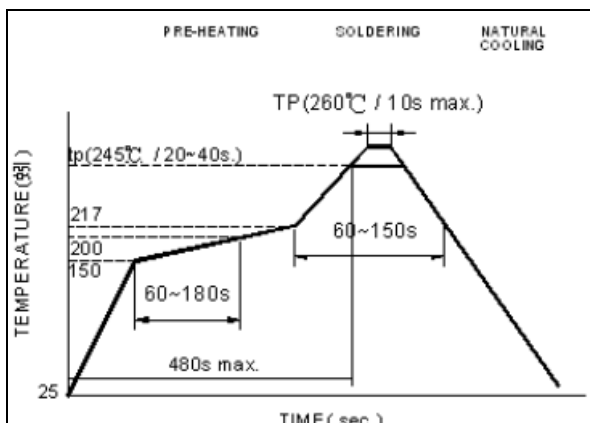

**■Packaging**

Packaging Quantity & Reel Specifications

Type	ΦA	ΦB	ΦC	W	Quantity (EA)
CFH10	178±2.0	60±2.0	13.5±0.5	9±0.5	2000
CFH12	178±2.0	60±2.0	13.5±0.5	9±0.5	500

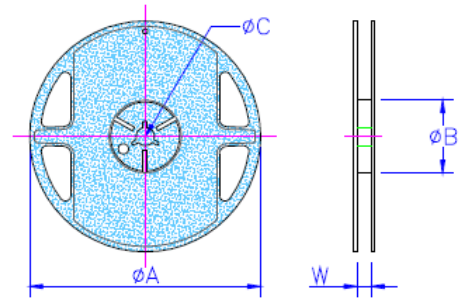

Embossed Plastic Tape Specifications

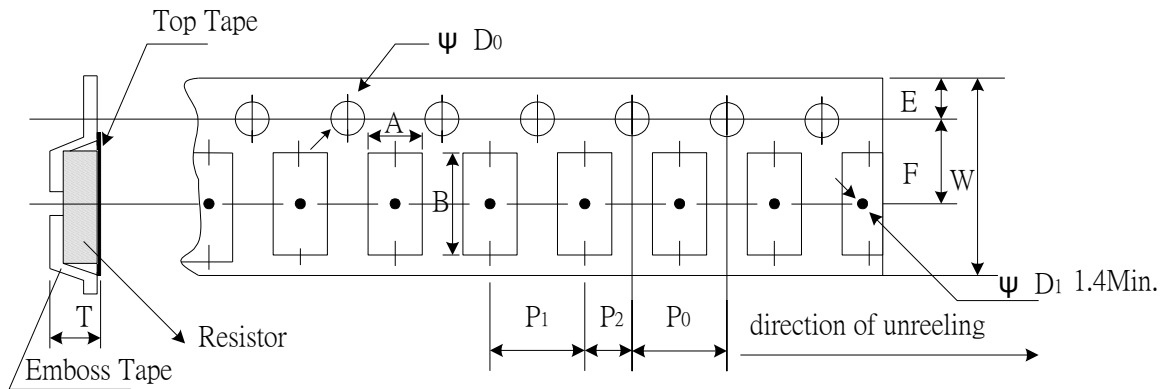

Unit: mm

Type	A	B	W	E	F	P0	P1	P2	ΦD <sub>0</sub>	T
CFH10	2.88±0.10	3.65±0.10	8.0±0.10	1.75±0.10	3.5±0.05	4.00±0.10	4.00±0.10	2.00±0.05	1.50±0.10	2.76±0.10
CFH12	3.60±0.10	4.90±0.10	12.0±0.10	1.75±0.10	5.5±0.05	4.00±0.10	8.00±0.10	2.00±0.05	1.50±0.10	3.26±0.10

Peel-off Force

The force for tearing off cover tape is 15~80g in the arrow direction at the following conditions:

Temperature: 5 ~ 35°C

Humidity: 45 ~ 85%

Atmospheric pressure: 860 ~ 1060hpa

Tearing speed: 300mm min

