

## Multilayer Chip Inductor

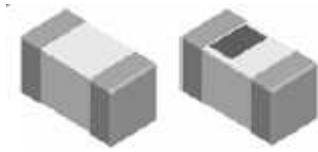

### Features

- Monolithic structure for high reliability
- High self-resonant frequency
- Excellent solderability and high heat resistance

### Applications

- RF circuit in telecommunication and other equipments

### Construction

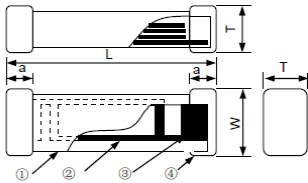

① Ceramic Material	③ Pull Out Electrode (Ag)
② Internal Electrode (Ag)	④ End-termination (Ag/Ni/Sn)

### Dimensions

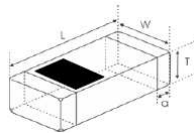

Figure1

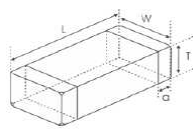

Figure2

#### Standard

Unit: mm

Type	Size (Inch)	Figure	L	W	T	a
CL02-S	0402	1	1.00±0.15	0.50±0.15	0.50±0.15	0.25±0.10
CL03-S (≤ 100nH)	0603	2	1.60±0.15	0.80±0.15	0.80±0.15	0.30±0.20
CL03-S (≥ 120nH)	0603	2	1.65±0.15	0.80±0.15	0.80±0.15	0.30±0.20

#### High Q

Unit: mm

Type	Size (Inch)	Figure	L	W	T	a
CL01-S	0201	1	0.60±0.05	0.30±0.05	0.30±0.05	0.12±0.05

#### High Frequency

Unit: mm

Type	Size (Inch)	Figure	L	W	T	a
CL02-S	0402	2	1.00±0.15	0.50±0.15	0.50±0.15	0.25±0.10
CL03-S	0603	2	1.60±0.15	0.80±0.15	0.80±0.15	0.30±0.20

### Part Numbering

CL	02	J	T		1N0	-S
Product Type	Dimensions	Inductance Tolerance	Packaging Code	Appearance	Inductance	
	01: 0201 02: 0402 03: 0603	J: ±5% K: ±10% S: ±0.3nH	T: Taping Reel	: Standard Q: High Q F: High Frequency	1N0: 1.0nH 39N: 39nH R10: 100nH	

**Standard Electrical Specifications**

CL02-S Multilayer Chip Inductors / Standard Type

Inductance (nH)	Tolerance	Quality Factor /min.	L/Q Freq. (MHz)	Q(Typical) Freq.(MHz)			SRF min. (GHz)	RDC (Ω) max.	IDC (mA) max.
				100	800	1000			
1.0	±0.3nH	8	100	11	34	36	10.00	0.10	400
1.1	±0.3nH	8	100	11	34	36	10.00	0.10	400
1.2	±0.3nH	8	100	11	34	36	10.00	0.10	400
1.3	±0.3nH	8	100	11	34	36	10.00	0.10	400
1.5	±0.3nH	8	100	11	34	36	6.00	0.10	300
1.6	±0.3nH	8	100	11	32	35	6.00	0.10	300
1.8	±0.3nH	8	100	11	30	34	6.00	0.10	300
2.0	±0.3nH	8	100	10	29	33	6.00	0.20	300
2.2	±0.3nH	8	100	10	29	33	6.00	0.20	300
2.4	±0.3nH	8	100	10	29	32	6.00	0.20	300
2.7	±0.3nH	8	100	10	29	32	6.00	0.20	300
3.0	±0.3nH	8	100	10	29	32	6.00	0.20	300
3.3	±0.3nH	8	100	10	29	32	6.00	0.20	300
3.6	±0.3nH	8	100	10	28	31	4.00	0.20	300
3.9	±0.3nH	8	100	10	28	31	4.00	0.20	300
4.3	±0.3nH	8	100	10	28	31	4.00	0.20	300
4.7	±0.3nH	8	100	10	28	31	4.00	0.20	300
5.1	±0.3nH	8	100	10	28	30	4.00	0.30	300
5.6	±0.3nH	8	100	10	28	30	4.00	0.30	300
6.2	±0.3nH	8	100	10	27	30	3.90	0.30	300
6.8	±5%, ±10%	8	100	10	27	30	3.90	0.30	300
7.5	±5%, ±10%	8	100	10	27	30	3.70	0.40	300
8.2	±5%, ±10%	8	100	10	27	30	3.60	0.40	300
9.1	±5%, ±10%	8	100	10	27	30	3.40	0.40	300
10	±5%, ±10%	8	100	10	27	30	3.20	0.40	300
12	±5%, ±10%	8	100	10	26	29	2.70	0.50	300
15	±5%, ±10%	8	100	10	26	28	2.30	0.50	300
18	±5%, ±10%	8	100	10	25	27	2.10	0.60	300
20	±5%, ±10%	8	100	10	25	26	2.00	0.60	300
22	±5%, ±10%	8	100	10	25	25	1.90	0.60	300
27	±5%, ±10%	8	100	10	25	23	1.60	0.70	300
33	±5%, ±10%	8	100	10	22	22	1.30	0.80	200
39	±5%, ±10%	8	100	10	22	19	1.20	1.00	200
43	±5%, ±10%	8	100	10	21	16	1.10	1.10	200
47	±5%, ±10%	8	100	10	21	16	1.00	1.10	200
56	±5%, ±10%	8	100	10	18	13	0.75	1.20	200
68	±5%, ±10%	8	100	10	18	9	0.75	1.40	180
82	±5%, ±10%	8	100	10	13	-	0.75	2.40	150
100	±5%, ±10%	8	100	10	12	-	0.70	2.60	150
120	±5%, ±10%	8	100	10	-	-	0.60	2.80	150
150	±5%, ±10%	8	100	10	-	-	0.55	3.20	100
180	±5%, ±10%	8	100	10	-	-	0.50	3.70	100
220	±5%, ±10%	8	100	12	-	-	0.45	4.00	100
270	±5%, ±10%	8	100	12	-	-	0.40	4.50	100
330	±5%, ±10%	6	50	-	-	-	0.35	7.00	50

Operating temperature range: -55~+125°C

**Standard Electrical Specifications**

CL03-S Multilayer Chip Inductors / Standard Type

Inductance (nH)	Tolerance	Quality Factor /min.	L/Q Freq. (MHz)	Q(Typical) Freq.(MHz)			SRF min. (GHz)	RDC (Ω) max.	IDC (mA) max.
				100	800	1000			
1.0	±0.3nH	8	100	13	70	80	10.00	0.05	500
1.2	±0.3nH	8	100	13	60	70	10.00	0.05	500
1.5	±0.3nH	8	100	13	47	68	6.00	0.10	500
1.8	±0.3nH	8	100	13	45	61	6.00	0.10	500
2.2	±0.3nH	8	100	13	45	60	6.00	0.10	500
2.7	±0.3nH	10	100	13	44	55	6.00	0.12	500
3.3	±0.3nH	10	100	13	43	50	6.00	0.15	500
3.9	±0.3nH	10	100	13	43	50	6.00	0.16	500
4.7	±0.3nH	10	100	13	43	50	6.00	0.20	500
5.6	±0.3nH	10	100	14	42	48	5.00	0.25	500
6.8	±5%, ±10%	10	100	14	43	50	5.00	0.30	500
8.2	±5%, ±10%	10	100	14	43	48	4.50	0.35	500
10	±5%, ±10%	12	100	15	45	50	3.50	0.40	300
12	±5%, ±10%	12	100	18	48	50	3.00	0.45	300
15	±5%, ±10%	12	100	18	48	50	2.30	0.50	300
18	±5%, ±10%	12	100	16	48	51	2.20	0.55	300
22	±5%, ±10%	12	100	16	45	48	2.00	0.60	300
27	±5%, ±10%	12	100	16	45	45	1.70	0.65	300
33	±5%, ±10%	12	100	16	45	41	1.50	0.70	300
39	±5%, ±10%	12	100	17	40	48	1.40	0.70	300
47	±5%, ±10%	12	100	17	35	35	1.20	0.70	300
56	±5%, ±10%	12	100	17	35	30	1.10	0.75	300
68	±5%, ±10%	12	100	17	30	20	0.90	0.85	300
82	±5%, ±10%	8	100	15	22	-	0.80	1.00	300
100	±5%, ±10%	8	100	15	16	-	0.70	1.20	300
120	±5%, ±10%	8	50	15	-	-	0.60	1.40	200
150	±5%, ±10%	8	50	15	-	-	0.50	1.60	200
180	±5%, ±10%	8	50	15	-	-	0.40	1.90	200
220	±5%, ±10%	8	50	15	-	-	0.35	2.40	200
270	±5%, ±10%	8	50	16	-	-	0.35	2.60	150
330	±5%, ±10%	8	50	16	-	-	0.35	2.80	150
390	±5%, ±10%	8	50	16	-	-	0.30	3.20	150
430	±5%, ±10%	8	50	16	-	-	0.28	3.40	150
470	±5%, ±10%	8	50	15	-	-	0.25	3.60	150
560	±5%, ±10%	8	50	15	-	-	0.25	4.00	100
680	±5%, ±10%	8	50	15	-	-	0.25	4.50	100

Operating temperature range: -40~+85°C

**High Q Electrical Specifications**

CL01-S Multilayer Chip Inductors / High Q Type

Inductance (nH)	Tolerance	Quality Factor /min.	L/Q Freq. (MHz)	Q (Typical) Freq.(MHz)					SRF (GHz) Min.	RDC (Ω) Max.	IDC (mA) Max.
				500	800	1800	2000	2400			
0.6	±0.1nH, ±0.2nH, ±0.3nH	13	500	>24	>32	>54	>57	>65	10.00	0.06	600
0.7	±0.1nH, ±0.2nH, ±0.3nH	13	500	>24	>32	>54	>57	>65	10.00	0.06	550
0.8	±0.1nH, ±0.2nH, ±0.3nH	13	500	>24	>32	>54	>57	>65	10.00	0.07	550
0.9	±0.1nH, ±0.2nH, ±0.3nH	13	500	>24	>32	>54	>57	>65	10.00	0.07	550
1.0	±0.1nH, ±0.2nH, ±0.3nH	13	500	24	32	54	57	65	10.00	0.08	520
1.1	±0.1nH, ±0.2nH, ±0.3nH	13	500	19	26	45	47	55	10.00	0.11	440
1.2	±0.1nH, ±0.2nH, ±0.3nH	13	500	19	25	43	44	52	10.00	0.12	420
1.3	±0.1nH, ±0.2nH, ±0.3nH	13	500	19	25	40	42	47	10.00	0.12	420
1.4	±0.1nH, ±0.2nH, ±0.3nH	13	500	19	24	39	41	47	10.00	0.11	440
1.5	±0.1nH, ±0.2nH, ±0.3nH	13	500	19	24	39	41	46	10.00	0.12	420
1.6	±0.1nH, ±0.2nH, ±0.3nH	13	500	19	24	39	41	46	10.00	0.13	410
1.7	±0.1nH, ±0.2nH, ±0.3nH	13	500	19	24	39	41	46	10.00	0.15	380
1.8	±0.1nH, ±0.2nH, ±0.3nH	13	500	19	24	39	41	46	10.00	0.15	380
1.9	±0.1nH, ±0.2nH, ±0.3nH	13	500	18	24	38	40	45	10.00	0.18	350
2.0	±0.1nH, ±0.2nH, ±0.3nH	13	500	17	24	38	39	44	10.00	0.23	300
2.1	±0.1nH, ±0.2nH, ±0.3nH	13	500	17	24	37	39	44	10.00	0.24	300
2.2	±0.1nH, ±0.2nH, ±0.3nH	13	500	17	24	38	40	43	10.00	0.25	290
2.3	±0.1nH, ±0.2nH, ±0.3nH	13	500	17	24	37	39	43	10.00	0.20	330
2.4	±0.1nH, ±0.2nH, ±0.3nH	13	500	17	23	36	38	42	10.00	0.22	310
2.5	±0.1nH, ±0.2nH, ±0.3nH	13	500	17	23	35	36	40	9.60	0.20	330
2.6	±0.1nH, ±0.2nH, ±0.3nH	13	500	17	22	34	35	39	9.40	0.20	330
2.7	±0.1nH, ±0.2nH, ±0.3nH	13	500	17	22	34	35	39	9.20	0.22	310
2.8	±0.1nH, ±0.2nH, ±0.3nH	13	500	17	22	34	35	39	8.90	0.24	300
2.9	±0.1nH, ±0.2nH, ±0.3nH	13	500	17	22	34	35	39	8.80	0.26	280
3.0	±0.1nH, ±0.2nH, ±0.3nH	13	500	17	22	34	35	39	8.60	0.26	280
3.1	±0.1nH, ±0.2nH, ±0.3nH	13	500	17	22	34	35	39	8.50	0.28	270
3.2	±0.1nH, ±0.2nH, ±0.3nH	13	500	17	22	33	35	39	8.20	0.28	270
3.3	±0.1nH, ±0.2nH, ±0.3nH	13	500	18	23	34	36	40	8.10	0.30	270
3.4	±0.1nH, ±0.2nH, ±0.3nH	13	500	17	23	33	35	39	8.00	0.30	270
3.5	±0.1nH, ±0.2nH, ±0.3nH	13	500	17	23	33	35	39	7.90	0.34	250
3.6	±0.1nH, ±0.2nH, ±0.3nH	13	500	16	23	33	35	39	7.70	0.38	240
3.7	±0.1nH, ±0.2nH, ±0.3nH	13	500	16	23	33	35	38	7.60	0.40	230
3.8	±0.1nH, ±0.2nH, ±0.3nH	13	500	16	22	33	35	38	7.50	0.42	230
3.9	±0.1nH, ±0.2nH, ±0.3nH	13	500	16	22	33	35	38	7.40	0.42	230
4.3	±0.1nH, ±0.2nH, ±0.3nH	13	500	16	21	32	34	37	6.80	0.44	220
4.7	±0.1nH, ±0.2nH, ±0.3nH	13	500	16	22	33	35	38	6.20	0.45	220
5.1	±0.1nH, ±0.2nH, ±0.3nH	13	500	17	22	34	36	38	5.90	0.46	210
5.6	±0.1nH, ±0.2nH, ±0.3nH	13	500	16	21	33	34	37	5.50	0.46	210
6.2	±0.1nH, ±0.2nH, ±0.3nH	13	500	18	23	34	35	37	5.10	0.48	210
6.8	±2%, ±3%, ±5%	13	500	17	22	32	33	35	4.90	0.50	200
7.5	±2%, ±3%, ±5%	13	500	16	21	31	33	34	4.70	0.50	200
8.2	±2%, ±3%, ±5%	13	500	16	21	31	32	34	4.30	0.56	190
9.1	±2%, ±3%, ±5%	13	500	16	20	30	31	32	4.10	0.72	170
10	±2%, ±3%, ±5%	13	500	16	20	28	29	31	3.80	0.80	160
12	±2%, ±3%, ±5%	13	500	16	20	27	28	28	3.40	0.80	160
15	±2%, ±3%, ±5%	13	500	15	19	24	24	23	2.60	0.85	160
18	±2%, ±3%, ±5%	13	500	15	19	23	24	22	2.30	1.00	140
22	±2%, ±3%, ±5%	13	500	15	19	22	23	20	1.90	1.20	130
27	±2%, ±3%, ±5%	13	500	15	19	15	13	8	1.80	1.60	120
33	±2%, ±3%, ±5%	11	500	14	15	8	5	-	1.80	2.20	110
39	±2%, ±3%, ±5%	11	500	14	15	6	-	-	1.60	2.30	100
47	±2%, ±3%, ±5%	11	500	14	15	-	-	-	1.50	2.60	100
56	±2%, ±3%, ±5%	11	500	13	13	-	-	-	1.40	2.80	80
68	±2%, ±3%, ±5%	11	500	13	11	-	-	-	1.20	3.20	80
82	±2%, ±3%, ±5%	10	500	12	10	-	-	-	1.10	3.80	70
100	±2%, ±3%, ±5%	10	500	12	10	-	-	-	1.00	4.00	60

Operating temperature range: -55~+125°C

**High Frequency Electrical Specifications**

CL02-S Multilayer Chip Inductors / High Frequency Type

Inductance (nH)	Tolerance	Quality Factor /min.	L/Q Freq. (MHz)	Q(Typical) Freq.(MHz)						SRF min. (GHz)	RDC (Ω) max.	IDC (mA) max.
				100	300	500	800	1000	1800			
1.0	±0.3nH	5	100	9	16	20	25	28	31	>8.50	0.10	500
1.2	±0.3nH	5	100	9	15	18	24	27	31	>8.50	0.12	500
1.5	±0.3nH	5	100	7	12	16	20	21	29	>8.50	0.15	500
1.8	±0.3nH	5	100	7	12	16	20	21	29	>8.50	0.17	500
2.2	±0.3nH	5	100	7	12	16	20	21	30	>8.50	0.17	500
2.7	±0.3nH	5	100	7	12	16	20	21	29	>8.50	0.20	500
3.3	±0.3nH	5	100	7	12	15	19	20	27	>8.50	0.22	400
3.9	±0.3nH	5	100	7	12	15	20	21	28	7.50	0.25	400
4.7	±0.3nH	5	100	7	12	15	19	20	27	6.50	0.28	400
5.6	±0.3nH	5	100	8	12	15	20	22	30	6.50	0.30	400
6.8	±0.3nH	5	100	8	12	15	20	22	30	6.50	0.35	400
8.2	±0.3nH	5	100	8	12	15	19	21	30	6.50	0.38	350
10	±5%, ±10%	5	100	8	13	16	21	23	32	4.70	0.42	350
12	±5%, ±10%	5	100	8	13	16	20	23	27	4.30	0.47	350
15	±5%, ±10%	5	100	8	12	15	19	22	28	4.00	0.50	300
18	±5%, ±10%	5	100	8	13	16	21	24	32	4.00	0.60	250
22	±5%, ±10%	5	100	8	13	17	22	26	31	3.50	0.70	200
27	±5%, ±10%	5	100	8	14	18	23	26	32	3.00	0.80	200
33	±5%, ±10%	5	100	8	14	17	23	27	32	2.50	0.90	200
39	±5%, ±10%	5	100	8	14	18	23	27	32	2.00	1.00	200
47	±5%, ±10%	7	100	9	14	18	22	24	29	2.40	2.20	100
56	±5%, ±10%	7	100	9	14	18	23	24	29	2.30	2.50	100
68	±5%, ±10%	7	100	9	14	17	22	24	29	2.20	2.70	100
82	±5%, ±10%	7	100	8	13	17	20	20	16	2.10	2.90	100
100	±5%, ±10%	7	100	8	13	17	20	20	13	2.00	3.20	100

Operating temperature range: -55~+125℃

**High Frequency Electrical Specifications**

CL03-S Multilayer Chip Inductors / High Frequency Type

Inductance (nH)	Tolerance	Quality Factor /min.	L/Q Freq. (MHz)	Q(Typical) Freq.(MHz)						SRF min. (GHz)	RDC (Ω) max.	IDC (mA) max.
				100	300	500	800	1000	1800			
10	±5%, ±10%	8	100	10	22	28	35	39	45	>6.00	0.6	500
12	±5%, ±10%	8	100	10	18	23	26	32	42	6.00	0.7	500
15	±5%, ±10%	8	100	12	22	28	35	39	42	5.50	0.8	500
18	±5%, ±10%	8	100	10	18	22	25	30	43	5.20	0.9	300
22	±5%, ±10%	8	100	12	21	27	34	37	37	5.00	1.0	300
27	±5%, ±10%	8	100	10	18	24	26	32	38	4.80	1.2	300
33	±5%, ±10%	8	100	12	21	27	33	35	31	4.50	1.4	300
39	±5%, ±10%	8	100	11	20	26	32	34	29	4.00	1.5	200
47	±5%, ±10%	8	100	12	20	26	31	34	27	3.50	1.6	200
56	±5%, ±10%	8	100	11	20	26	31	34	24	3.00	1.8	200
68	±5%, ±10%	8	100	10	18	21	24	28	10	2.80	2.0	200
82	±5%, ±10%	8	100	10	19	22	26	26	15	2.50	2.2	200
100	±5%, ±10%	8	100	10	19	24	27	25	-	2.00	2.5	150
120	±5%, ±10%	8	100	10	19	23	26	24	-	1.60	2.8	150
150	±5%, ±10%	8	100	10	18	24	26	23	-	1.40	3.0	150
180	±5%, ±10%	8	100	10	17	22	23	-	-	1.00	3.4	150

Operating temperature range: -40~+85°C

**Environmental Characteristics**

Electrical Performance Test

Item	Requirement	Test Condition
Inductance	In Within specified tolerance	Temperature: 20±1°C Relative Humidity: 45 to 85%RH Atmospheric Pressure: 86 to 106kpa Measuring equipment and fixture: 0201: E991A+HP16197A 0402/0603: E991A+HP16192A Test Signal: -20dBm or 50mV Test compensation(for 0201 high Q): Product true value= test value + compensation value. for L<3.6nH, compensation value is 0.25nH; for 3.6nH≤L<6.8nH, compensation value is 0.43nH; for 6.8 nH≤L<9.1nH, compensation value is 0.5nH; for L≥9.1nH, compensation value is 0.85nH;
Q Value	In accordance with electrical specification	Temperature: 20±1°C Relative Humidity: 45 to 85%RH Atmospheric Pressure: 86 to 106kpa
DC Resistance	In accordance with electrical specification	Temperature: 20±1°C Relative Humidity: 45 to 85%RH Atmospheric Pressure: 86 to 106kpa Measuring equipment: HP 4338

Mechanical Characteristics Test

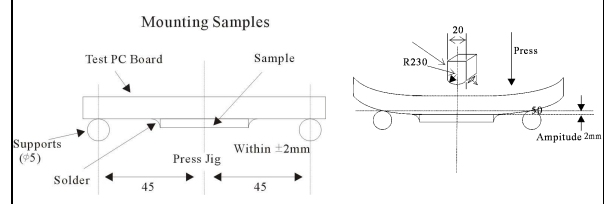
Item	Requirement	Test Condition
Bending Strength	No mechanical damage shall be observed	Flexure: 2mm Pressurizing speed: 0.5mm/sec Keep time: 30sec  
Solderability	No visible mechanical damage Wetting shall exceed 75% coverage for 0201 series; exceed 95% coverage for others	Solder temperature: 240±2°C Time: 3 seconds Solder: Sn/3.0Ag/0.5Cu Flux: 25% resin and 75% ethanol in weight
Resistance to Soldering Heat	No visible mechanical damage Wetting shall exceed 75% coverage for 0201 series; exceed 95% coverage for others Inductance change: within±10% Q change: within±20%	Solder temperature: 260±3°C Time: 5 seconds Solder: Sn/3.0Ag/0.5Cu Flux: 25% resin and 75% ethanol in weight The chip shall be stabilized at normal condition for 1~2 hours before measuring
Dropping	No visible mechanical damage Inductance change: within±10% Q change: within±20%	Drop chip inductor 10 times on a concrete floor from a height of 100cm

Climatic Test

Item	Requirements	Test Condition
Thermal Shock		0201/0402 series: -55°C for 30±3 min→125°C for 30±3 min 0603 series: -40°C for 30±3 min→85°C for 30±3 min Transforming interval: max. 20 seconds Test cycle: 100 cycles The chip shall be stabilized at normal condition for 1~2 hours Before measuring
Resistance to Low Temperature		Temperature: 0201/0402 series: -55±2°C ; 0603 series: -40±2°C Time: 1000±24 hours The chip shall be stabilized at normal condition for 1~2 hours Before measuring
Resistance to High Temperature	No visible damage	Temperature: 0201/0402 series: 125±2°C ; 0603 series: 85±2°C Time: 1000±24 hours The chip shall be stabilized at normal condition for 1~2 hours Before measuring
Damp Heat (Steady States)	Inductance variation within 10% Q variation within 20%	Temperature: 60±2°C Humidity: 90~95% RH. Time: 1000±24 hours The chip shall be stabilized at normal condition for 1~2 hours Before measuring
Loading Under Damp Heat		Temperature: 60±2°C Humidity: 90~95% RH. Time: 1000±24 hours Applied current: Rated current The chip shall be stabilized at normal condition for 1~2 hours Before measuring
Loading at High Temperature (Life Test)		Temperature: 0201/0402 series: 125±2°C ; 0603 series: 85±2°C Time: 1000±24 hours Applied current: Rated current The chip shall be stabilized at normal condition for 1~2 hours Before measuring

**■Packaging Specifications**

Reel Dimension

Unit: mm

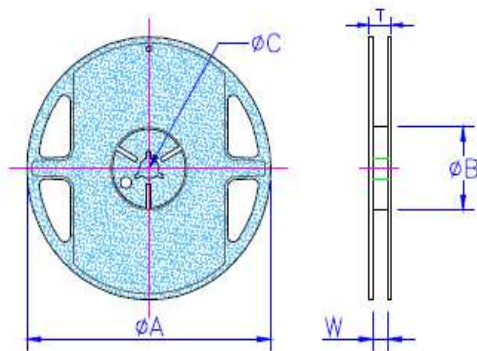

Type	A	B	C	W	T	Quantity (EA)
CL01-S	178±1	60.0±0.5	13.0±0.20	9.00±0.5	12.0±0.15	15,000
CL02-S	178±1	60.0±0.5	13.0±0.20	9.00±0.5	12.0±0.15	10,000
CL03-S	178±1	60.0±0.5	13.0±0.20	9.00±0.5	12.0±0.15	4,000

Tape Specifications

Unit: mm

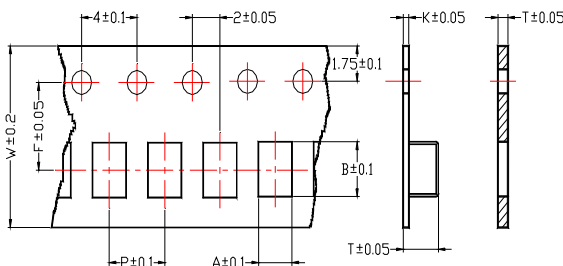

Type	A	B	T	W	P	F	K	Tape
CL01-S	0.40	0.70	0.50	8	2	3.5	-	B
CL02-S	0.65	1.15	0.80	8	2	3.5	-	B
CL03-S	1.10	1.80	1.10	8	4	3.5	-	B

**Type A** **Type B**