

Data Sheet

Customer :

Product : Thin Film Chip Inductor - AL Series

Size.: 0201/0402

Issued Date : 20-Aug-15

Edition: REV.C5



VIKING TECH CORPORATION
光頡科技股份有限公司

No.70, Kuanfu N. Rad.,
Hsin Chu Industrial Park,
Hukou Hsiang, Hsin Chu Hsien,
303, Taiwan

TEL:886-3-5972931

FAX:886-3-5972935•886-3-5973494

E-mail:sales@viking.com.tw

VIKING TECH CORPORATION KAOHSIUNG BRANCH
光頡科技股份有限公司高雄分公司

No.248-3, Sin-Sheng Rd., Cian-Jhen Dist., Kaohsiung,
806, Taiwan

TEL:886-7-8217999

FAX:886-7-8228229

E-mail:sales@viking.com.tw

WUXI TMTEC CO., LTD.
無錫泰銘電子有限公司

No.1A,(Xixia Road),Machinery & Industry Park,
National Hi-Tech Industrial Development Zone of
Wuxi, Wuxi, Jiangsu Province, China

Zip Code:214028

TEL:86-510-85203339

FAX:86-510-85203667•86-510-85203977

E-mail:wuxisales@tmtec.com.tw

Produced by (QC)	Checked by (QC)	Approved by (QC)	Prepared by (Sales)	Accepted by (Customer)
20-Aug-15	20-Aug-15	20-Aug-15	20-Aug-15	
<i>Chun</i>	<i>Ben Chang</i>	<i>Ben Chang</i>		

Thin Film Chip Inductor

■ Scope

– Viking's 0201 and 0402 series inductor is a photo lithographically etched single layer ceramic chip. Viking's design provides high SRF, excellent Q, and superior temperature stability. This highly stable inductor family is specifically designed for critical tolerance needs.

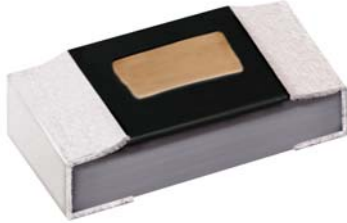

■ Features

- Photolithographic single layer ceramic chip
- High SRF, excellent Q, superior temperature stability
- Tight tolerance of $\pm 1\%$ or $\pm 0.1\text{nH}$
- Self resonant frequency controlled within 10%
- Stable inductance in high frequency circuit
- Highly stable design for critical needs

■ Applications

- Cellular Telephone, Pagers and GPS Products
- VCO, TCXO Circuit and RF Transceiver Module
- Wireless LAN, Bluetooth Module, Communication Appliances

■ Construction

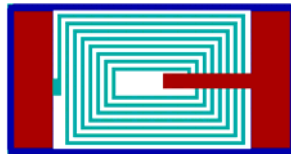
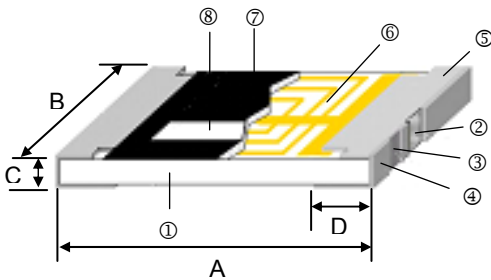

① Alumina Substrate	④ External Electrode (Sn)	⑦ Overcoat
② Inner Electrode (Ni-Cr)	⑤ Edge Electrode	⑧ Marking
③ Barrier Layer (Ni)	⑥ Cu Circuits	

■ Dimensions

Unit: mm

Type	Size (Inch)	A	B	C	D	Weight (g) (1000pcs)
AL01	0201	0.60 \pm 0.05	0.30 \pm 0.05	0.23 \pm 0.05	0.15 \pm 0.05	0.23
AL02	0402	1.0 \pm 0.05	0.5 \pm 0.05	0.32 \pm 0.05	0.2 \pm 0.10	0.9

■ Part Numbering

AL	02	G	T	10N	
Product Type	Dimensions 01: 0201 02: 0402	Inductance Tolerance B: $\pm 0.1\text{nH}$ C: $\pm 0.2\text{nH}$ S: $\pm 0.3\text{nH}$ F: $\pm 1\%$ G: $\pm 2\%$ H: $\pm 3\%$ J: $\pm 5\%$	Packaging Code T: Taping Reel	Inductance 1N0: 1nH 10N: 10nH 20N8: 20.8nH	:Standard 01: High Current 02: High Q

■ Viking is capable of manufacturing the optional spec based on customer's requirement.

Standard Electrical Specifications

AL01 Chip Inductors / Standard Type

Inductance (nH)	Inductance Tolerance (nH or %)	Quality Factor min.	SRF (GHz) min.	DCR (Ω) max.	IDC (mA) max.
0.1	±0.1, 0.2, 0.3nH	8 / 500MHz	9	0.20	400
0.2	±0.1, 0.2, 0.3nH	8 / 500MHz	9	0.20	400
0.3	±0.1, 0.2, 0.3nH	8 / 500MHz	9	0.20	400
0.4	±0.1, 0.2, 0.3nH	8 / 500MHz	9	0.25	350
0.5	±0.1, 0.2, 0.3nH	8 / 500MHz	9	0.25	350
0.6	±0.1, 0.2, 0.3nH	8 / 500MHz	9	0.25	350
0.7	±0.1, 0.2, 0.3nH	8 / 500MHz	9	0.30	300
0.8	±0.1, 0.2, 0.3nH	8 / 500MHz	9	0.30	300
0.9	±0.1, 0.2, 0.3nH	8 / 500MHz	9	0.30	300
1.0	±0.1, 0.2, 0.3nH	8 / 500MHz	9	0.30	300
1.1	±0.1, 0.2, 0.3nH	8 / 500MHz	9	0.35	300
1.2	±0.1, 0.2, 0.3nH	8 / 500MHz	9	0.35	300
1.3	±0.1, 0.2, 0.3nH	8 / 500MHz	9	0.45	250
1.4	±0.1, 0.2, 0.3nH	8 / 500MHz	9	0.45	250
1.5	±0.1, 0.2, 0.3nH	8 / 500MHz	9	0.45	250
1.6	±0.1, 0.2, 0.3nH	8 / 500MHz	9	0.55	200
1.7	±0.1, 0.2, 0.3nH	8 / 500MHz	9	0.55	200
1.8	±0.1, 0.2, 0.3nH	8 / 500MHz	9	0.55	200
1.9	±0.1, 0.2, 0.3nH	8 / 500MHz	9	0.55	200
2.0	±0.1, 0.2, 0.3nH	8 / 500MHz	8	0.70	200
2.1	±0.1, 0.2, 0.3nH	8 / 500MHz	8	0.70	200
2.2	±0.1, 0.2, 0.3nH	8 / 500MHz	8	0.70	200
2.3	±0.1, 0.2, 0.3nH	8 / 500MHz	8	0.80	150
2.4	±0.1, 0.2, 0.3nH	8 / 500MHz	8	0.80	150
2.5	±0.1, 0.2, 0.3nH	8 / 500MHz	8	0.80	150
2.6	±0.1, 0.2, 0.3nH	8 / 500MHz	8	0.80	150
2.7	±0.1, 0.2, 0.3nH	8 / 500MHz	8	0.80	150
2.8	±0.1, 0.2, 0.3nH	8 / 500MHz	6	1.00	150
2.9	±0.1, 0.2, 0.3nH	8 / 500MHz	6	1.00	150
3.0	±0.1, 0.2, 0.3nH	8 / 500MHz	6	1.00	150
3.1	±0.1, 0.2, 0.3nH	8 / 500MHz	6	1.00	150
3.2	±0.1, 0.2, 0.3nH	8 / 500MHz	6	1.00	150
3.3	±0.1, 0.2, 0.3nH	8 / 500MHz	6	1.00	150
3.4	±0.1, 0.2, 0.3nH	8 / 500MHz	6	1.20	150
3.5	±0.1, 0.2, 0.3nH	8 / 500MHz	6	1.20	150
3.6	±0.1, 0.2, 0.3nH	8 / 500MHz	6	1.20	150
3.7	±0.1, 0.2, 0.3nH	8 / 500MHz	6	1.20	150
3.8	±0.1, 0.2, 0.3nH	8 / 500MHz	6	1.20	150
3.9	±0.1, 0.2, 0.3nH	8 / 500MHz	6	1.20	150
4.0	±0.1, 0.2, 0.3nH	8 / 500MHz	6	1.20	150
4.4	±0.1, 0.2, 0.3nH	8 / 500MHz	6	1.30	140
4.7	±0.1, 0.2, 0.3nH	8 / 500MHz	6	1.40	130
4.9	±0.1, 0.2, 0.3nH	8 / 500MHz	6	1.60	130
5.6	±2, ±5%	8 / 500MHz	4	1.80	130
6.1	±2, ±5%	8 / 500MHz	4	2.00	120
6.8	±2, ±5%	8 / 500MHz	4	2.30	110
7.4	±2, ±5%	8 / 500MHz	4	2.80	110
8.2	±2, ±5%	8 / 500MHz	3	3.00	110
9.1	±2, ±5%	8 / 500MHz	3	3.25	100
9.2	±2, ±5%	8 / 500MHz	3	3.25	100
10	±2, ±5%	8 / 500MHz	2	3.50	80

Operating Temperature Range: -40°C to +85°C

Test Equipment: HP4287A+Agilent 16196C

AL01-01 Chip Inductors / High Current Type

Inductance (nH)	Inductance Tolerance (nH or %)	Quality Factor min.	SRF (GHz) min.	DCR (Ω) max.	IDC (mA) max.
0.1	±0.1, 0.2, 0.3nH	10 / 500MHz	6	0.05	600
0.2	±0.1, 0.2, 0.3nH	10 / 500MHz	6	0.05	600
0.3	±0.1, 0.2, 0.3nH	10 / 500MHz	6	0.05	600
0.4	±0.1, 0.2, 0.3nH	10 / 500MHz	6	0.05	600
0.5	±0.1, 0.2, 0.3nH	10 / 500MHz	6	0.10	600
0.6	±0.1, 0.2, 0.3nH	10 / 500MHz	6	0.10	600
0.7	±0.1, 0.2, 0.3nH	10 / 500MHz	6	0.10	600
0.8	±0.1, 0.2, 0.3nH	10 / 500MHz	6	0.10	600
0.9	±0.1, 0.2, 0.3nH	10 / 500MHz	6	0.10	600
1.0	±0.1, 0.2, 0.3nH	10 / 500MHz	6	0.15	600
1.1	±0.1, 0.2, 0.3nH	10 / 500MHz	6	0.15	600
1.2	±0.1, 0.2, 0.3nH	10 / 500MHz	6	0.15	600
1.3	±0.1, 0.2, 0.3nH	10 / 500MHz	6	0.20	600
1.4	±0.1, 0.2, 0.3nH	10 / 500MHz	6	0.20	600
1.5	±0.1, 0.2, 0.3nH	10 / 500MHz	6	0.25	600
1.6	±0.1, 0.2, 0.3nH	10 / 500MHz	6	0.25	600
1.7	±0.1, 0.2, 0.3nH	10 / 500MHz	6	0.30	500
1.8	±0.1, 0.2, 0.3nH	10 / 500MHz	6	0.30	500
1.9	±0.1, 0.2, 0.3nH	10 / 500MHz	6	0.30	500
2.0	±0.1, 0.2, 0.3nH	10 / 500MHz	6	0.30	500
2.1	±0.1, 0.2, 0.3nH	10 / 500MHz	6	0.30	500
2.2	±0.1, 0.2, 0.3nH	10 / 500MHz	6	0.35	500
2.3	±0.1, 0.2, 0.3nH	10 / 500MHz	6	0.35	500
2.4	±0.1, 0.2, 0.3nH	10 / 500MHz	6	0.35	450
2.5	±0.1, 0.2, 0.3nH	10 / 500MHz	6	0.35	450
2.6	±0.1, 0.2, 0.3nH	10 / 500MHz	6	0.35	450
2.7	±0.1, 0.2, 0.3nH	10 / 500MHz	6	0.35	450
2.8	±0.1, 0.2, 0.3nH	10 / 500MHz	6	0.50	450
2.9	±0.1, 0.2, 0.3nH	10 / 500MHz	6	0.50	450
3.0	±0.1, 0.2, 0.3nH	10 / 500MHz	6	0.50	400
3.1	±0.1, 0.2, 0.3nH	10 / 500MHz	6	0.50	400
3.2	±0.1, 0.2, 0.3nH	10 / 500MHz	6	0.50	400
3.3	±0.1, 0.2, 0.3nH	10 / 500MHz	6	0.50	400
3.4	±0.1, 0.2, 0.3nH	10 / 500MHz	6	0.80	350
3.5	±0.1, 0.2, 0.3nH	10 / 500MHz	6	0.80	350
3.6	±0.1, 0.2, 0.3nH	10 / 500MHz	6	0.80	350
3.7	±0.1, 0.2, 0.3nH	10 / 500MHz	6	0.80	350
3.8	±0.1, 0.2, 0.3nH	10 / 500MHz	6	0.80	350
3.9	±0.1, 0.2, 0.3nH	10 / 500MHz	6	0.80	350
4.0	±0.1, 0.2, 0.3nH	10 / 500MHz	6	0.80	350
4.4	±0.1, 0.2, 0.3nH	10 / 500MHz	6	0.50	300
4.7	±0.1, 0.2, 0.3nH	10 / 500MHz	6	0.50	300
4.9	±0.1, 0.2, 0.3nH	10 / 500MHz	6	0.60	300
5.6	±2, ±5%	10 / 500MHz	6	0.60	250
6.1	±2, ±5%	10 / 500MHz	5.5	0.70	250
6.8	±2, ±5%	10 / 500MHz	5	0.75	250
7.4	±2, ±5%	10 / 500MHz	5	0.80	200
8.2	±2, ±5%	10 / 500MHz	4.5	0.90	200
9.1	±2, ±5%	10 / 500MHz	4	1.05	175
9.2	±2, ±5%	10 / 500MHz	4	1.15	150
10	±2, ±5%	10 / 500MHz	3.5	1.30	150

Operating Temperature Range: -40°C to +85°C

Test Equipment: HP4287A+Agilent 16196C

AL01-02 Chip Inductors / High Q Type

Inductance (nH)	Inductance Tolerance (nH or %)	Quality Factor min.	SRF (GHz) min.	DCR (Ω) max.	IDC (mA) max.
0.1	$\pm 0.1, 0.2, 0.3nH$	14 / 500MHz	10	0.05	850
0.2	$\pm 0.1, 0.2, 0.3nH$	14 / 500MHz	10	0.05	800
0.3	$\pm 0.1, 0.2, 0.3nH$	14 / 500MHz	10	0.05	800
0.4	$\pm 0.1, 0.2, 0.3nH$	14 / 500MHz	10	0.05	750
0.5	$\pm 0.1, 0.2, 0.3nH$	14 / 500MHz	10	0.10	750
0.6	$\pm 0.1, 0.2, 0.3nH$	14 / 500MHz	9	0.10	750
0.7	$\pm 0.1, 0.2, 0.3nH$	14 / 500MHz	9	0.10	600
0.8	$\pm 0.1, 0.2, 0.3nH$	14 / 500MHz	9	0.10	600
0.9	$\pm 0.1, 0.2, 0.3nH$	14 / 500MHz	9	0.10	600
1.0	$\pm 0.1, 0.2, 0.3nH$	14 / 500MHz	9	0.15	600
1.1	$\pm 0.1, 0.2, 0.3nH$	14 / 500MHz	8	0.15	600
1.2	$\pm 0.1, 0.2, 0.3nH$	14 / 500MHz	8	0.15	600
1.3	$\pm 0.1, 0.2, 0.3nH$	14 / 500MHz	8	0.15	600
1.4	$\pm 0.1, 0.2, 0.3nH$	14 / 500MHz	8	0.15	600
1.5	$\pm 0.1, 0.2, 0.3nH$	14 / 500MHz	8	0.15	600
1.6	$\pm 0.1, 0.2, 0.3nH$	14 / 500MHz	8	0.15	600
1.7	$\pm 0.1, 0.2, 0.3nH$	14 / 500MHz	8	0.2	500
1.8	$\pm 0.1, 0.2, 0.3nH$	14 / 500MHz	8	0.2	500
1.9	$\pm 0.1, 0.2, 0.3nH$	14 / 500MHz	8	0.2	500
2.0	$\pm 0.1, 0.2, 0.3nH$	14 / 500MHz	8	0.2	500
2.1	$\pm 0.1, 0.2, 0.3nH$	14 / 500MHz	7.5	0.2	500
2.2	$\pm 0.1, 0.2, 0.3nH$	14 / 500MHz	7.5	0.2	500
2.3	$\pm 0.1, 0.2, 0.3nH$	14 / 500MHz	7.5	0.2	500
2.4	$\pm 0.1, 0.2, 0.3nH$	14 / 500MHz	7.5	0.25	450
2.5	$\pm 0.1, 0.2, 0.3nH$	14 / 500MHz	7.5	0.25	450
2.6	$\pm 0.1, 0.2, 0.3nH$	14 / 500MHz	7.5	0.25	450
2.7	$\pm 0.1, 0.2, 0.3nH$	14 / 500MHz	7.5	0.25	450
2.8	$\pm 0.1, 0.2, 0.3nH$	14 / 500MHz	7.5	0.25	450
2.9	$\pm 0.1, 0.2, 0.3nH$	14 / 500MHz	7.5	0.25	450
3.0	$\pm 0.1, 0.2, 0.3nH$	14 / 500MHz	7.5	0.3	400
3.1	$\pm 0.1, 0.2, 0.3nH$	14 / 500MHz	7	0.3	400
3.2	$\pm 0.1, 0.2, 0.3nH$	14 / 500MHz	7	0.3	400
3.3	$\pm 0.1, 0.2, 0.3nH$	14 / 500MHz	7	0.3	400
3.4	$\pm 0.1, 0.2, 0.3nH$	14 / 500MHz	7	0.4	350
3.5	$\pm 0.1, 0.2, 0.3nH$	14 / 500MHz	7	0.4	350
3.6	$\pm 0.1, 0.2, 0.3nH$	14 / 500MHz	7	0.4	350
3.7	$\pm 0.1, 0.2, 0.3nH$	14 / 500MHz	7	0.4	350
3.8	$\pm 0.1, 0.2, 0.3nH$	14 / 500MHz	6.5	0.4	350
3.9	$\pm 0.1, 0.2, 0.3nH$	14 / 500MHz	6.5	0.4	350
4.0	$\pm 0.1, 0.2, 0.3nH$	14 / 500MHz	6.5	0.4	350
4.4	$\pm 0.1, 0.2, 0.3nH$	14 / 500MHz	6.5	0.5	300
4.7	$\pm 0.1, 0.2, 0.3nH$	14 / 500MHz	6	0.5	300
4.9	$\pm 0.1, 0.2, 0.3nH$	14 / 500MHz	6	0.6	300
5.6	$\pm 2, \pm 5\%$	14 / 500MHz	6	0.6	250
6.1	$\pm 2, \pm 5\%$	14 / 500MHz	5.5	0.7	250
6.8	$\pm 2, \pm 5\%$	14 / 500MHz	5	0.75	250
7.4	$\pm 2, \pm 5\%$	14 / 500MHz	5	0.8	200
8.2	$\pm 2, \pm 5\%$	14 / 500MHz	4.5	0.9	200
9.1	$\pm 2, \pm 5\%$	14 / 500MHz	4	1.05	175
9.2	$\pm 2, \pm 5\%$	14 / 500MHz	4	1.15	150
10	$\pm 2, \pm 5\%$	14 / 500MHz	3.5	1.3	150

Operating Temperature Range: -40°C to +85°C

Test Equipment: HP4287A+Agilent 16196B

AL02 Chip Inductors / Standard Type

Inductance (nH)	Inductance Tolerance (nH or %)	Quality Factor min.	SRF (GHz) min.	DCR (Ω) max.	IDC (mA) max.
0.2	±0.1, 0.2, 0.3nH	13 / 500MHz	14	0.10	800
0.3	±0.1, 0.2, 0.3nH	13 / 500MHz	14	0.10	800
0.4	±0.1, 0.2, 0.3nH	13 / 500MHz	14	0.10	800
0.5	±0.1, 0.2, 0.3nH	13 / 500MHz	14	0.15	700
0.6	±0.1, 0.2, 0.3nH	13 / 500MHz	14	0.15	700
0.8	±0.1, 0.2, 0.3nH	13 / 500MHz	14	0.15	700
0.9	±0.1, 0.2, 0.3nH	13 / 500MHz	14	0.15	700
1.0	±0.1, 0.2, 0.3nH	13 / 500MHz	12	0.15	700
1.1	±0.1, 0.2, 0.3nH	13 / 500MHz	12	0.15	700
1.2	±0.1, 0.2, 0.3nH	13 / 500MHz	12	0.15	700
1.3	±0.1, 0.2, 0.3nH	13 / 500MHz	10	0.25	700
1.4	±0.1, 0.2, 0.3nH	13 / 500MHz	10	0.25	700
1.5	±0.1, 0.2, 0.3nH	13 / 500MHz	10	0.25	700
1.6	±0.1, 0.2, 0.3nH	13 / 500MHz	10	0.25	560
1.7	±0.1, 0.2, 0.3nH	13 / 500MHz	10	0.25	560
1.8	±0.1, 0.2, 0.3nH	13 / 500MHz	10	0.25	560
1.9	±0.1, 0.2, 0.3nH	13 / 500MHz	8	0.35	560
2.0	±0.1, 0.2, 0.3nH	13 / 500MHz	8	0.35	560
2.1	±0.1, 0.2, 0.3nH	13 / 500MHz	8	0.35	440
2.2	±0.1, 0.2, 0.3nH	13 / 500MHz	8	0.35	440
2.3	±0.1, 0.2, 0.3nH	13 / 500MHz	8	0.35	440
2.4	±0.1, 0.2, 0.3nH	13 / 500MHz	8	0.35	440
2.5	±0.1, 0.2, 0.3nH	13 / 500MHz	8	0.35	440
2.6	±0.1, 0.2, 0.3nH	13 / 500MHz	8	0.35	440
2.7	±0.1, 0.2, 0.3nH	13 / 500MHz	8	0.35	440
2.8	±0.1, 0.2, 0.3nH	13 / 500MHz	6	0.45	380
2.9	±0.1, 0.2, 0.3nH	13 / 500MHz	6	0.45	380
3.0	±0.1, 0.2, 0.3nH	13 / 500MHz	6	0.45	380
3.1	±0.1, 0.2, 0.3nH	13 / 500MHz	6	0.45	380
3.2	±0.1, 0.2, 0.3nH	13 / 500MHz	6	0.45	380
3.3	±0.1, 0.2, 0.3nH	13 / 500MHz	6	0.45	380
3.4	±0.1, 0.2, 0.3nH	13 / 500MHz	6	0.55	380
3.5	±0.1, 0.2, 0.3nH	13 / 500MHz	6	0.55	380
3.6	±0.1, 0.2, 0.3nH	13 / 500MHz	6	0.55	380
3.7	±0.1, 0.2, 0.3nH	13 / 500MHz	6	0.55	340
3.8	±0.1, 0.2, 0.3nH	13 / 500MHz	6	0.55	340
3.9	±0.1, 0.2, 0.3nH	13 / 500MHz	6	0.55	340
4.3	±0.1, 0.2, 0.3nH	13 / 500MHz	6	0.65	320
4.7	±0.1, 0.2, 0.3nH	13 / 500MHz	6	0.65	320
5.4	±0.1, 0.2, 0.3nH	13 / 500MHz	6	0.85	280
5.6	±0.1, 0.2, 0.3nH	13 / 500MHz	6	0.85	280
5.9	±0.1, 0.2, 0.3nH	13 / 500MHz	6	0.85	280
6.5	±0.1, 0.2, 0.3nH	13 / 500MHz	6	1.05	260
6.8	±0.1, 0.2, 0.3nH	13 / 500MHz	6	1.05	260
7.2	±0.1, 0.2, 0.3nH	13 / 500MHz	6	1.05	260
8.0	±0.1, 0.2, 0.3nH	13 / 500MHz	5.5	1.25	220
8.1	±0.1, 0.2, 0.3nH	13 / 500MHz	5.5	1.25	220
8.2	±0.1, 0.2, 0.3nH	13 / 500MHz	5.5	1.25	220
9.1	±0.1, 0.2, 0.3nH	13 / 500MHz	5.5	1.25	220
10.0	±1, 2, 3, 5%	13 / 500MHz	4.5	1.35	200
10.8	±1, 2, 3, 5%	13 / 500MHz	4.5	1.35	200
12.0	±1, 2, 3, 5%	13 / 500MHz	3.7	1.55	180
13.8	±1, 2, 3, 5%	13 / 500MHz	3.7	1.75	180
15.0	±1, 2, 3, 5%	13 / 500MHz	3.3	1.75	130
17.0	±1, 2, 3, 5%	13 / 500MHz	3.1	1.95	100
18.0	±1, 2, 3, 5%	13 / 500MHz	3.1	2.15	100
20.8	±1, 2, 3, 5%	13 / 500MHz	2.8	2.55	90
22.0	±1, 2, 3, 5%	13 / 500MHz	2.8	2.65	90
27.0	±1, 2, 3, 5%	13 / 500MHz	2.5	3.25	75
33.0	±5%	13 / 500MHz	2.5	4.50	75

Operating Temperature Range: -40°C to +85°C

Test Equipment: HP4287A+Agilent 16196B

AL02-02 Chip Inductors / High Q Type

Inductance (nH)	Inductance Tolerance (nH or %)	Quality Factor min.	SRF (GHz) min.	DCR (Ω) max.	IDC (mA) max.
0.2	±0.1, 0.2, 0.3nH	16 / 500MHz	14	0.1	1000
0.3	±0.1, 0.2, 0.3nH	16 / 500MHz	14	0.1	1000
0.4	±0.1, 0.2, 0.3nH	16 / 500MHz	14	0.1	1000
0.5	±0.1, 0.2, 0.3nH	16 / 500MHz	14	0.12	850
0.6	±0.1, 0.2, 0.3nH	16 / 500MHz	14	0.12	850
0.7	±0.1, 0.2, 0.3nH	16 / 500MHz	14	0.12	850
0.8	±0.1, 0.2, 0.3nH	16 / 500MHz	14	0.12	850
0.9	±0.1, 0.2, 0.3nH	16 / 500MHz	14	0.12	850
1.0	±0.1, 0.2, 0.3nH	16 / 500MHz	12	0.12	850
1.1	±0.1, 0.2, 0.3nH	16 / 500MHz	12	0.12	850
1.2	±0.1, 0.2, 0.3nH	16 / 500MHz	12	0.12	850
1.3	±0.1, 0.2, 0.3nH	16 / 500MHz	10	0.2	850
1.4	±0.1, 0.2, 0.3nH	16 / 500MHz	10	0.2	850
1.5	±0.1, 0.2, 0.3nH	16 / 500MHz	10	0.2	850
1.6	±0.1, 0.2, 0.3nH	16 / 500MHz	10	0.2	675
1.7	±0.1, 0.2, 0.3nH	16 / 500MHz	10	0.2	675
1.8	±0.1, 0.2, 0.3nH	16 / 500MHz	10	0.2	675
1.9	±0.1, 0.2, 0.3nH	16 / 500MHz	8	0.28	675
2.0	±0.1, 0.2, 0.3nH	16 / 500MHz	8	0.28	675
2.1	±0.1, 0.2, 0.3nH	16 / 500MHz	8	0.28	530
2.2	±0.1, 0.2, 0.3nH	16 / 500MHz	8	0.28	530
2.3	±0.1, 0.2, 0.3nH	16 / 500MHz	8	0.28	530
2.4	±0.1, 0.2, 0.3nH	16 / 500MHz	8	0.28	530
2.5	±0.1, 0.2, 0.3nH	16 / 500MHz	8	0.28	530
2.6	±0.1, 0.2, 0.3nH	16 / 500MHz	8	0.28	530
2.7	±0.1, 0.2, 0.3nH	16 / 500MHz	8	0.28	530
2.8	±0.1, 0.2, 0.3nH	16 / 500MHz	6	0.35	460
2.9	±0.1, 0.2, 0.3nH	16 / 500MHz	6	0.35	460
3.0	±0.1, 0.2, 0.3nH	16 / 500MHz	6	0.35	460
3.1	±0.1, 0.2, 0.3nH	16 / 500MHz	6	0.35	460
3.2	±0.1, 0.2, 0.3nH	16 / 500MHz	6	0.35	460
3.3	±0.1, 0.2, 0.3nH	16 / 500MHz	6	0.35	460
3.4	±0.1, 0.2, 0.3nH	16 / 500MHz	6	0.45	460
3.5	±0.1, 0.2, 0.3nH	16 / 500MHz	6	0.45	460
3.6	±0.1, 0.2, 0.3nH	16 / 500MHz	6	0.45	460
3.7	±0.1, 0.2, 0.3nH	16 / 500MHz	6	0.45	410
3.8	±0.1, 0.2, 0.3nH	16 / 500MHz	6	0.45	410
3.9	±0.1, 0.2, 0.3nH	16 / 500MHz	6	0.45	410
4.3	±0.1, 0.2, 0.3nH	16 / 500MHz	6	0.55	350
4.7	±0.1, 0.2, 0.3nH	16 / 500MHz	6	0.55	350
5.4	±0.1, 0.2, 0.3nH	16 / 500MHz	6	0.7	310
5.6	±0.1, 0.2, 0.3nH	16 / 500MHz	6	0.7	310
5.9	±0.1, 0.2, 0.3nH	16 / 500MHz	6	0.7	310
6.5	±0.1, 0.2, 0.3nH	16 / 500MHz	6	0.9	290
6.8	±0.1, 0.2, 0.3nH	16 / 500MHz	6	0.9	290
7.2	±0.1, 0.2, 0.3nH	16 / 500MHz	6	0.9	290
8.0	±0.1, 0.2, 0.3nH	16 / 500MHz	5.5	1.0	245
8.1	±0.1, 0.2, 0.3nH	16 / 500MHz	5.5	1.0	245
8.2	±0.1, 0.2, 0.3nH	16 / 500MHz	5.5	1.0	245
9.1	±0.1, 0.2, 0.3nH	16 / 500MHz	5.5	1.0	245
10	±1, 2, 3, 5%	16 / 500MHz	4.5	1.1	220

Operating Temperature Range: -40°C to +85°C

Test Equipment: HP4287A+Agilent 16196B

■ Environmental Characteristics

Item	Requirement	Test Method
Inductance	As Spec.	Measuring equipment and fixture: 0201: HP4287+Agilent 16196C 0402: HP4287+Agilent 16196B
Insulation Resistance	>1000MΩ	MIL-STD-202 Method 302 Apply 100V _{DC} for 1minute
Damp Heat with Load	$\Delta L \leq 10\%$	MIL-STD-202 Method 103B 40±2°C, 90~95% R.H. Max. working voltage for 1000 hrs with 1.5 hrs "ON" and 0.5 hrs "OFF"
Bending Strength	As Spec.	JIS-C-5201-1 6.1.4 Bending Amplitude 3mm for 10 seconds
Solderability	95% min. coverage	MIL-STD-202 Method 208H 245±5°C for 3 seconds
Resistance to Soldering Heat	$\Delta L \leq 10\%$	MIL-STD-202 Method 210E 260±5°C for 10 seconds
Dielectric Withstand Voltage	>100V	MIL-STD-202 Method 301 Apply 100VA (rms) for 1minute
High Temperature Exposure	$\Delta L \leq 10\%$	JIS-C-5201-1 7.2 85±2°C, 1000 +48/-0 hours
Low Temperature Storage	$\Delta L \leq 10\%$	JIS-C-5201-1 7.1 -40±3°C, 1000 +48/-0 hours
Temperature Cycle	$\Delta L \leq 10\%$	JIS-C-5201-1 7.4 -40/RT/85/RT, 10 cycles

■ Storage Temperature: 25±3°C; Humidity < 80%RH

■ Reflow

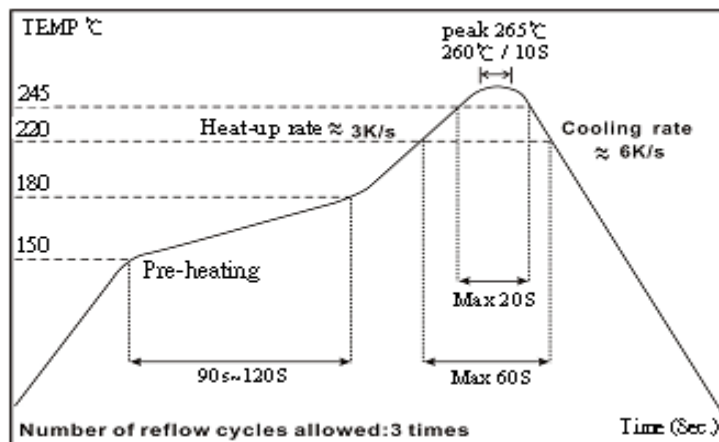

■ Packaging

Reel Specifications & Packaging Quantity

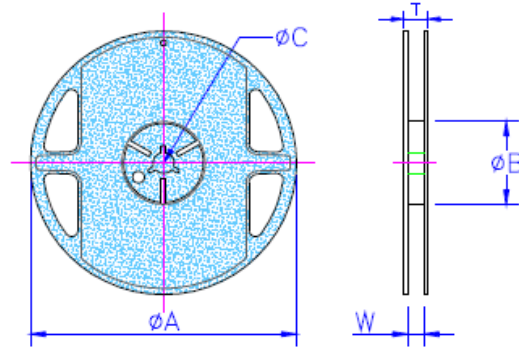

Unit: mm

Type	ψA	ψB	ψC	W	T	Quantity (EA)
AL01	178±1.0	60.0±1.0	13.5±0.70	9.5±1.0	11.5±1.0	10,000
AL02	178±1.0	60.0±1.0	13.5±0.70	9.5±1.0	11.5±1.0	10,000

Paper Tape Specifications

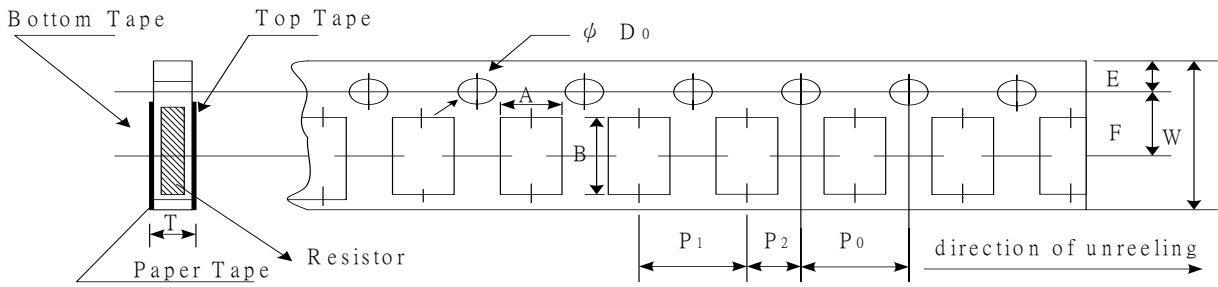

Unit: mm

Type	A	B	W	E	F	P0	P1	P2	$\psi D0$	T
AL01	0.40±0.05	0.70±0.05	8.00±0.10	1.75±0.05	3.50±0.05	4.00±0.10	2.00±0.05	2.00±0.05	1.55±0.03	0.42±0.02
AL02	0.70±0.05	1.16±0.05	8.00±0.10	1.75±0.05	3.50±0.05	4.00±0.10	2.00±0.05	2.00±0.05	1.55±0.05	0.40±0.03

Remark : Test Method

Test direction : bar mark faces left

■ Recommend Land Pattern

Unit: mm

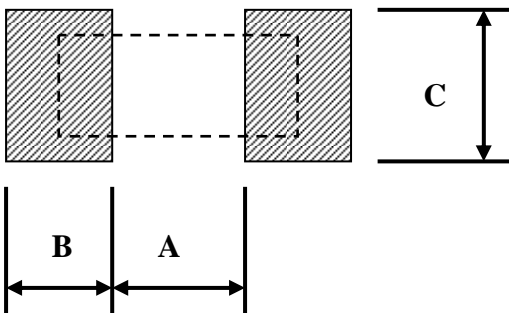

Type	A	B	C
AL01	0.30	0.25	0.30±0.2
AL02	0.50	0.45	0.60±0.2

REVISION HISTORY

REVISION	DATE	CHANGE NOTIFICATION	DESCRIPTION
Version C2	Feb. 27,2013	-	- Add AL01-02 (High Q) specification - Delete AL0603 series specification
Version C3	May 07,2015	-	- Modify SRF specifications of AL01-02 Type (from 6.0 to 6.5~10). - Add 4.4~10nH specifications of AL01-01 and AL01-02 Types.
Version C4	Jun. 02,2015	-	- Add AL02-02 Chip Inductors / High Q Type specification.
Version C5	Aug. 20,2015	-	- Note Operating Temperature Range and Test Equipment. - Correct the Inductance Tolerance for AL01-02 5.6~10 nH.