

REV.	DESCRIPTION	DRAWN	CHECKED	APPROVED
A	NEW RELEASE	LL 07/07/06'		

Female TERMINAL

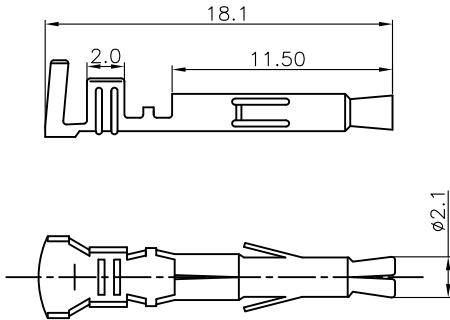

MALE Terminal

Wire Range		O.D of Wire
Section Area (mm ²)	AWG#	mm
0.13~1.25	26~16	1.3~2.7

NOTES:

1. MAIN SPECIFICATIONS

- . Housing material: NYLON 66
- . Wire range: AWG#26~#16
- . Rated voltage: 300V
- . Rated current: 1A
- . Contact resistance: $\leq 0.01\Omega$
- . Insulation resistance: $\geq 1000M\Omega$
- . Withstanding voltage: 500V,AC 1 minute
- . Temperature range: $-25 \sim +85^{\circ}C$
- . Recommend PC board thickness:1.6~2.0mm

2. PRODUCT NUMBER CODE:

DS1069-02 - X X X X X X

Housing type
A: ELR-02P
B: ELR-03P
C: ELR-04P SINGLE ROW
D: ELR-04P DUAL ROWS
F: ELR-06P

Contact Plating
6: Tin
8: Full gold flash
Housing Color
W: White
T: Transparent
Mounting type
C: Crimp

Connector type
M: Male
F: Female
No.of contact
2 3 4

Male TERMINAL

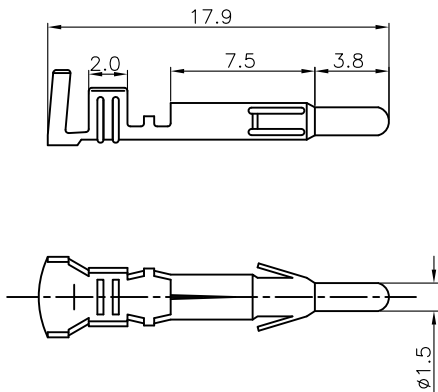

Female Terminal

Wire Range		O.D of Wire
Section Area (mm ²)	AWG#	mm
0.13~1.25	26~16	1.3~2.7

GENERAL TOLERANCE		ANGLE TOLERANCE		PROJECTION	TITLE
X.	± 0.60	X.	$\pm 5^{\circ}$		P.C.B CONNECTOR 4.5mm EL TYPE
.X	± 0.38	.X	$\pm 3^{\circ}$	mm	
.XX	± 0.25	.XX	$\pm 2^{\circ}$	A4	SERIES DS1069-02 SERIES
DRAWING TYPE	CUSTOMER			晨翔电子有限公司 CONNFLY ELECTRONIC CO. LTD	
SCALE	1:1	SHEET	1 OF 2		
DRAWING NO.	C-DS1069-02-XXXXX				

FEMALE

ELR-02P Housing type A

MALE

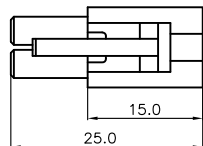
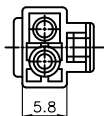
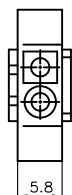
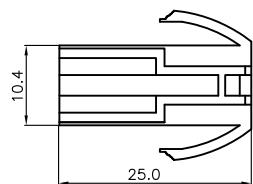

ELR-04P Housing type D

FEMALE

MALE

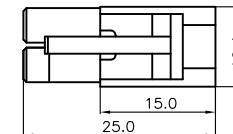
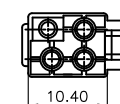
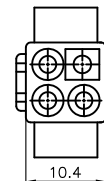
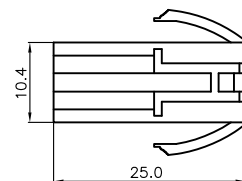

ELR-03P Housing type B

FEMALE

MALE

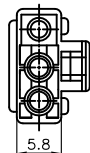
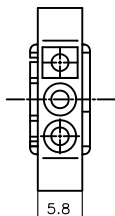
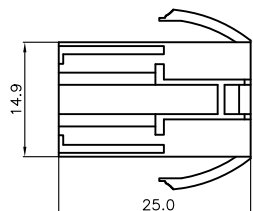

ELR-06P Housing type F

FEMALE

MALE

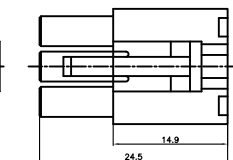
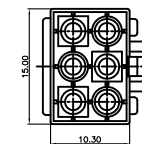
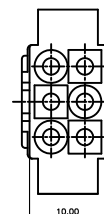
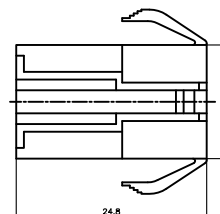

FEMALE

ELR-04P Housing type C

MALE

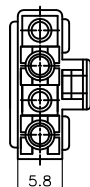
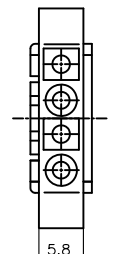
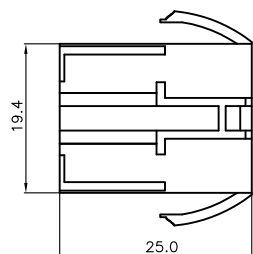

GENERAL TOLERANCE ANGLE TOLERANCE

X. ±0.60
.X ±0.38
.XX ±0.25

X. ±5°
.X ±3°
.XX ±2°

PROJECTION

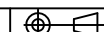

TITLE

P.C.B CONNECTOR 4.5mm EL TYPE

UNITS

mm

SHEET SIZE

A4

SERIES

DS1069-02 SERIES

DRAWING TYPE CUSTOMER

SCALE

1:1

SHEET

2 OF 2

DRAWING NO.

C-DS1069-02-XXXXX



晨翔电子有限公司

CONNFLY CONNFLY ELECTRONIC CO. LTD